



Description

Gas Discharge Tube (GDT) is a single-gap or multi-gap switching overvoltage protection device. Under normal circumstances, the GDT is in a high-impedance state; when suffer a surge, the GDT will change from a high-impedance state to a low-impedance state, and release the surge energy to the ground, reducing the residual voltage of the circuit, thereby protecting the equipment circuit or protect the human body from the hazards of transient overvoltage. GDT is formed by high-temperature sealing of metal electrodes, metallized ceramics, inert gas or other mixed gases.

Features

- Fast Response
- Stable Performance Over Surface Life
- High Current Rating
- Low Capacitance
- High Insulation Resistance
- RoHS & REACH Compliant

Applications

- WLAN XDSL
- CATV
- MDF
- Ethernet
- BTS (Base Station)
- Power Supply
- Antenna and RF
- Consumer Electronics

Part Numbering System

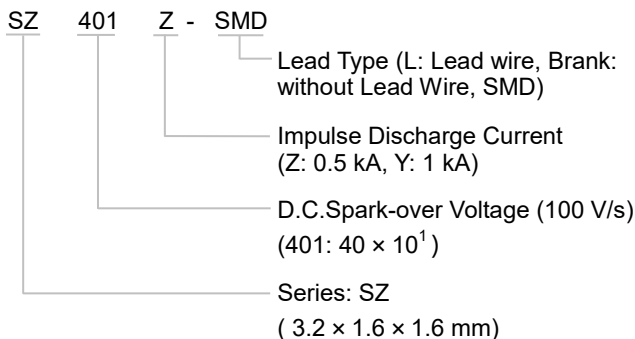

Reminder:

Part numbering system in the datasheet is only for selecting correct parameter and product features. Before placing order, please contact us for specifications and use the part number and product code in the specifications to place order to ensure the part is correct. Product code is the unique identification.

Agency Information

Agency Symbol	Standards	The File No. and certification No. obtained by SETsafe SETfuse
	UL497B	E513446

Dimensions (mm)

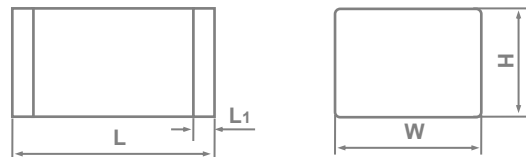

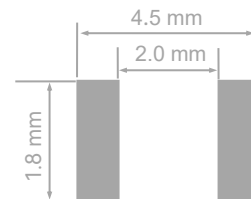

L	W	H	L ₁
3.2 ± 0.3	1.6 ± 0.2	1.6 ± 0.2	0.3 ± 0.2

Recommendation Pad Size (mm)



Specifications

Model	D.C. Spark-over Voltage @100 V/s	Tolerance of V_s	Impulse Spark-over Voltage @1 kV/ μ s	Arc Voltage @0.5 A	Impulse Discharge Current @8/20 μ s	Alternating Discharge Current @50Hz 1 s	Insulation Resistance		Capacitance 0.5 VDC @ 1MHz	Agency Approvals	
	V_s	V_s	V	V_a	I_n	I	VDC	IR	C		
	V	V	V	V	kA	A (r.m.s.)	V	G Ω	(pF)	UL497B	TUV
SZ091Z - SMD	90	63 ~ 118	≤ 900	≈ 8	0.5	0.5	50	≥ 1	≤ 0.5	●	○
SZ151Z - SMD	150	105 ~ 195	≤ 900	≈ 10	0.5	0.5	50	≥ 1	≤ 0.5	●	○
SZ201Z - SMD	200	140 ~ 280	≤ 900	≈ 10	0.5	0.5	100	≥ 1	≤ 0.5	●	○
SZ231Z - SMD	230	161 ~ 300	≤ 1000	≈ 10	0.5	0.5	100	≥ 1	≤ 0.5	●	○
SZ301Z - SMD	300	210 ~ 390	≤ 1100	≈ 12	0.5	0.5	100	≥ 1	≤ 0.5	●	○
SZ401Z - SMD	400	280 ~ 520	≤ 1200	≈ 12	0.5	0.5	100	≥ 1	≤ 0.5	●	○

Note:

1. The above parameters based on ITU - T K12 & IEC61643.311 standards.
2. "●" means GDT has gained the certification.
"○" means GDT is no certification.

Electrical Characteristics

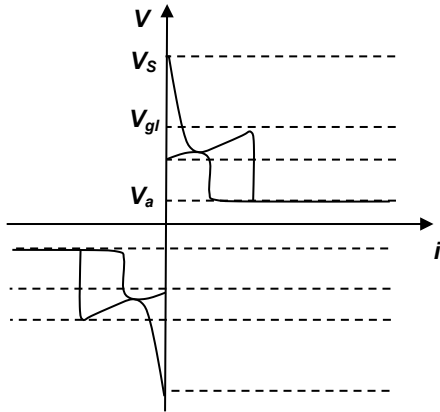

Relationship between Current and Voltage

- V_s : Spark-over Voltage
- V_{gl} : Glow Voltage
- V_a : Arc Voltage
- G : Glow Mode
- A : Arc Mode

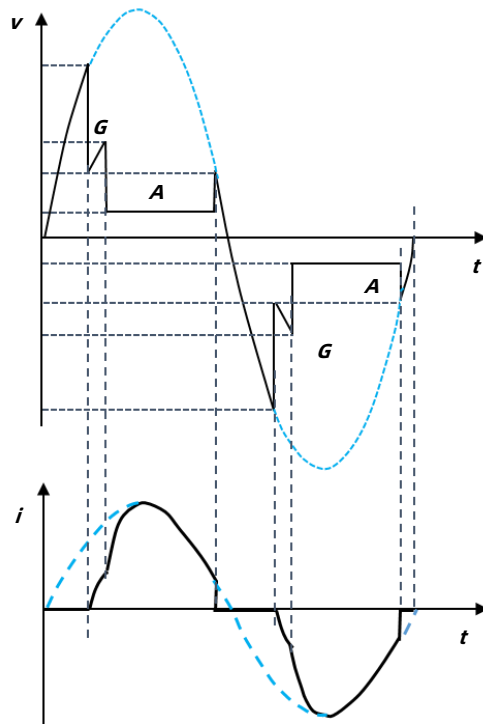

Time Variation Patterns of Voltage and Current

Reference Curve for Spark-over Voltage (Refer to 230 VDC)

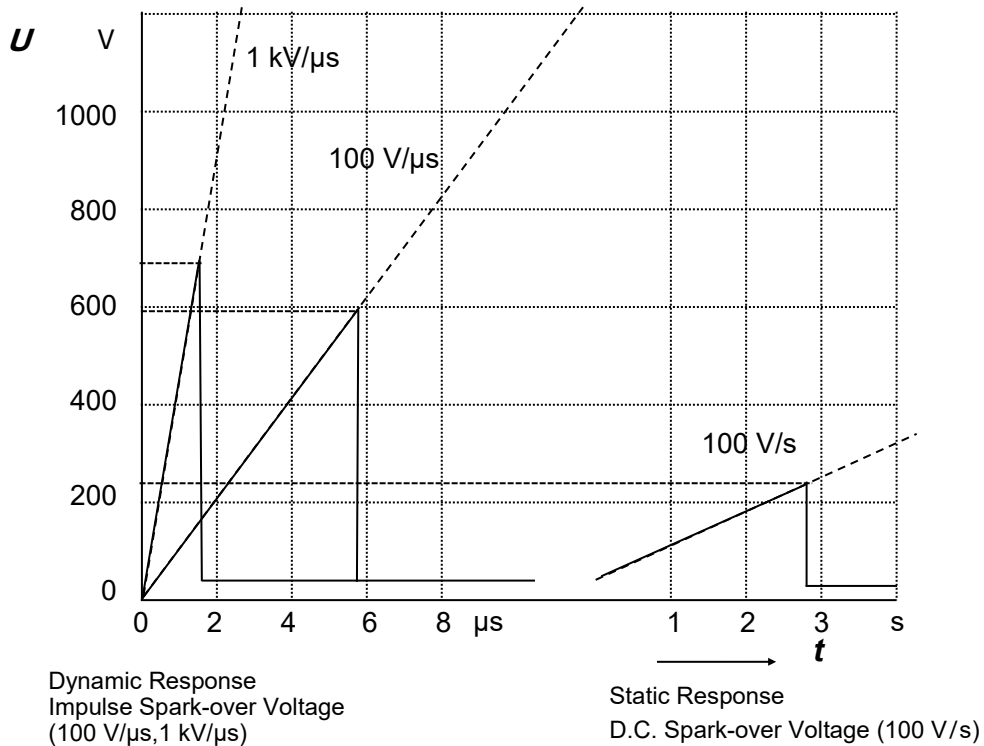

Curve for Impulse Discharge Current (For Reference Only)

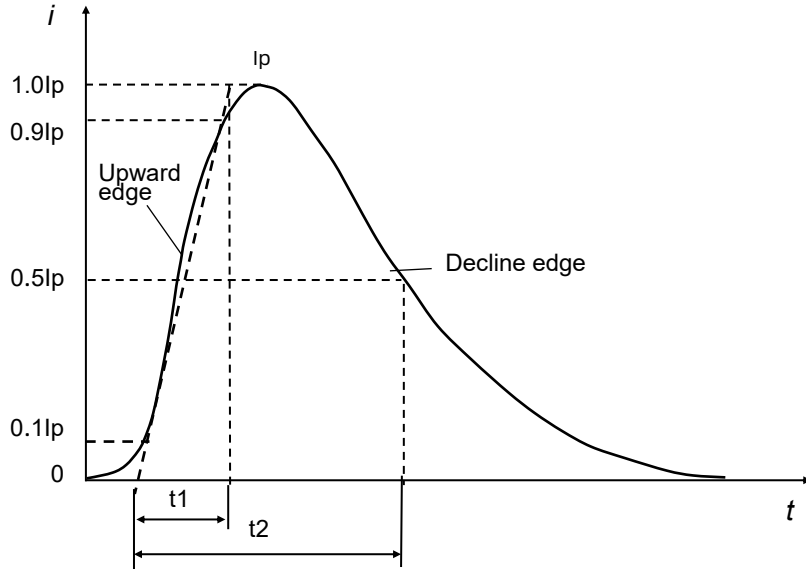

I_p : Peak current
 t_1 : Rise time in μs
 t_2 : Delay time to half value in μs

Application Example (For Reference Only)

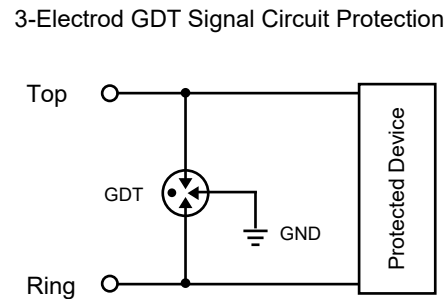
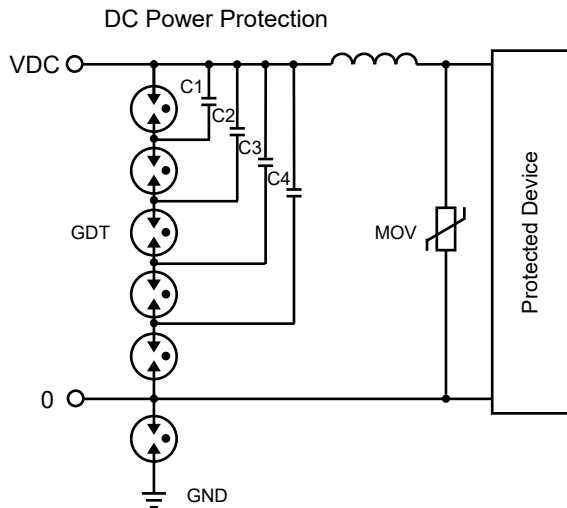
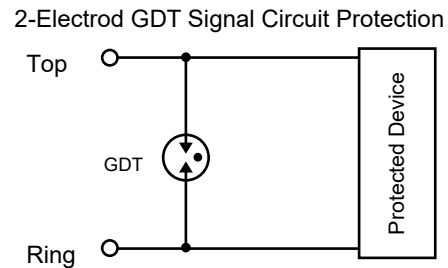
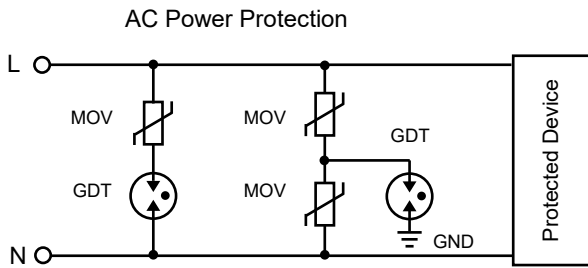

Reflow Soldering Parameters (For Reference Only)

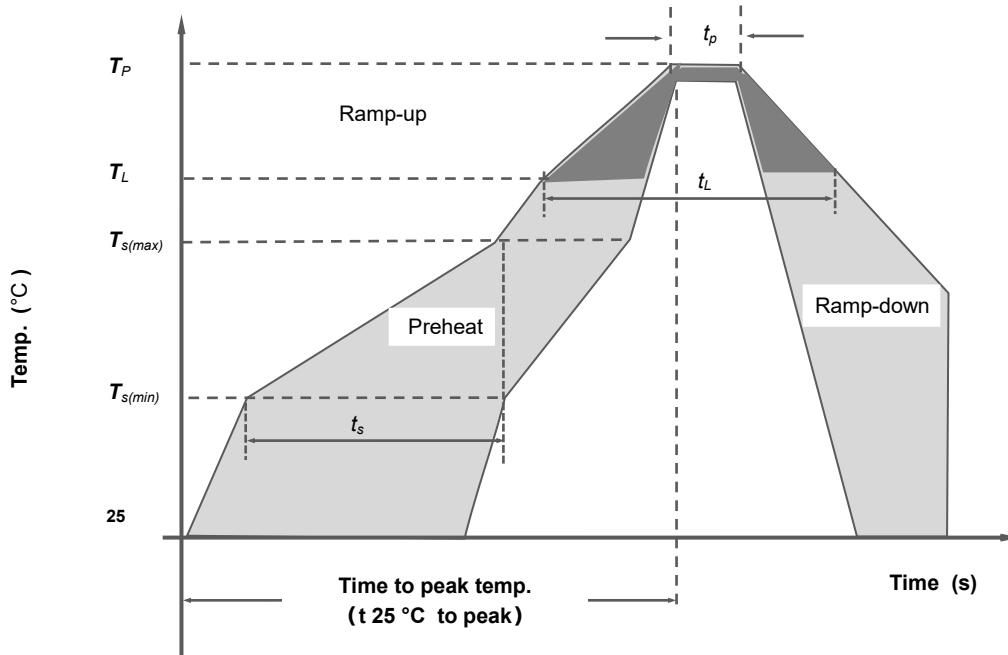

Reflow Condition		Pb-Free Assembly
Preheat	Temp. Min $T_{s(min)}$	150 °C
	Temp. Max $T_{s(max)}$	200 °C
	Time (Min to Max) t_s	(60 to 180) s
Average ramp up rate (Liquidus Temp. (T_L) to peak)		3 °C / second max
$T_{s(max)}$ to T_L Ramp-up Rate		5 °C / second max
Reflow	Temp. (T_L) (Liquidus)	217 °C
	Temp. (t_L)	(60 to 150) s
Peak Temp. (T_P)		(255 to 260) °C
Time within 5 °C of actual peak Temp. (t_p)		(10 to 30) s
Ramp-down Rate		6 °C / second max
Time 25 °C to peak Temp. (T_P)		8 minutes max
Do not exceed		260 °C

Packaging Information

Tape & Reel (SMD)

Item	Reel	Inner Box	Carton
Dimensions (mm)	Φ178 × 16.5	200 × 200 × 30	440 × 250 × 230
Quantity (PCS)	3000	3000	60000
Notes: Packaging dimensions and quantity are for reference only.			



Glossary

Item	Description
V_s	<p>D.C. Spark-over Voltage</p> <p>The voltage at which the GDT sparks over with slowly increasing d.c. voltage.</p> <p style="text-align: right;">— (IEC 61643-311)</p>
V	<p>Impulse Spark-over Voltage</p> <p>The highest Voltage which appears across the terminals of a GDT in the period between the application of an impulse of given wave-shape and the time when current begins to flow.</p> <p style="text-align: right;">— (ITU-T K.12)</p>
V_a	<p>Arc Voltage</p> <p>Voltage drop across the GDT during arc current flow.</p> <p style="text-align: right;">— (IEC 61643-311)</p>
V_{gl}	<p>Glow Voltage</p> <p>The peak value of the voltage drop across the GDT when a glow-current is flowing, It is sometimes called the glow mode voltage.</p> <p style="text-align: right;">— (ITU-T K.12)</p>
$8/20 \mu s$	<p>8/20 Current Impulse</p> <p>Current impulse with a nominal virtual front time of 8 μs and a nominal time to half-value of 20 μs.</p> <p style="text-align: right;">— (IEC 61643-11)</p>
$1.2/50 \mu s$	<p>1.2/50 Voltage Impulse</p> <p>Voltage impulse with a nominal virtual front time of 1.2 μs and a nominal time to half-value of 50 μs.</p> <p style="text-align: right;">— (IEC 61643-11)</p>
I	<p>Alternating Discharge Current</p> <p>The r.m.s. value of an approximately sinusoidal alternating current passing through the GDT.</p> <p style="text-align: right;">— (ITU-T K.12)</p>
I_n	<p>Nominal Discharge Current</p> <p>Crest value of the current through the GDT having a current waveshape of 8/20 μs.</p> <p style="text-align: right;">— (IEC 61643-11)</p>
I_{max}	<p>Maximum Discharge Current</p> <p>Crest value of a current through the GDT having an 8/20 μs waveshape and magnitude according to the manufacturers specification. I_{max} is equal to or greater than I_n.</p> <p style="text-align: right;">— (IEC 61643-11)</p>



ATTENTION

Usage

1. Do not operate GDT in power supply networks, whose maximum operation voltage exceeds the minimum spark-overvoltage of the GDT.
2. The GDT may become hot in the event of longer periods of current stress (burn risk). In the event of overload the connectors may fail or the component may be destroyed.
3. If the contacts of GDT are defective, current load can cause sparks and loud noises.
4. When air pressure is from 55 kPa to 106 kPa. The relative altitude shall be +5000 m to -500 m.

Replacement

The GDT is a non-repairable product. For safety sake, please use equivalent GDT for replacement.

Storage

The packaged GDT should be placed in a dry, ventilation and non-corrosive environment.

Installation Position

Do not install the GDT in a touchable position.



Mechanical Stress

Do not take violent action such as knocking when assembling, to avoid product failure.

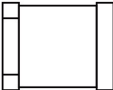
Gas Discharge Tube (GDT) Features & Model List Overview

DC Spark-over Voltage (V)	Model								
		SW	SX	SY	SN	SU	SS	SD(-SMD)	SM
4500	○	○	○	○	○	○	○	○	○
4000	○	○	○	○	○	○	○	○	○
3600	○	○	○	○	○	○	○	○	○
3000	○	○	○	○	○	○	○	○	○
2500	○	○	○	○	○	○	○	○	○
2000	○	○	○	○	○	○	○	○	○
1500	○	○	○	○	○	○	○	○	○
1200	○	○	○	○	○	○	○	○	○
1000	○	○	○	○	○	○	○	○	○
800	○	SW	SX	SY	SN	SU	SS	SD(-SMD)	SM
600	○	SW	SX	SY	SN	SU	SS	SD(-SMD)	SM
470	○	SW	SX	SY	SN	SU	SS	SD(-SMD)	SM
420	○	SW	SX	SY	SN	SU	SS	SD(-SMD)	SM
400	SZ	SW	SX	SY	SN	○	○	○	○
350	○	SW	SX	SY	SN	SU	SS	SD(-SMD)	SM
300	SZ	SW	SX	SY	SN	○	○	○	○
250	○	○	○	○	○	SU	SS	SD(-SMD)	SM
230	SZ	SW	SX	SY	SN	SU	SS	SD(-SMD)	SM
200	SZ	SW	SX	SY	SN	○	○	○	○
150	SZ	SW	SX	SY	SN	SU	SS	SD(-SMD)	SM
90	SZ	SW	SX	SY	SN	SU	SS	SD(-SMD)	SM
75	○	SW	SX	SY	SN	○	SS	SD(-SMD)	SM
70	○	○	○	○	SN	○	SS	SD(-SMD)	SM
Size (mm)	3.2 × 1.6 × 1.6	3.2 × 2.5 × 2.5	4.5 × 3.2 × 2.7	4.0 × 3.5 × 3.5	4.2 × 5.0 × 5.0	5.0 × 5.4 × 5.4	4.2 × 6.2 × 6.2	Φ5.0 × 5.0	Φ9.3 × 6.0
I_n (8/20 μs) (kA) Impulse Discharge Current	0.5	1	1 / 2	3	5	5 / 10	5	5	20
Product Structure									
						SMD			

Gas Discharge Tube (GDT) Features & Model List Overview

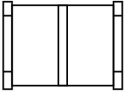
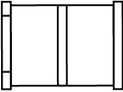
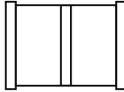
DC Spark-over Voltage (V)	Model					
	SK	SC	TS	TZ(-SMD)	TY	TR(-SMD)
4500	○	○	○	○	○	○
4000	○	○	○	○	○	○
3600	○	○	○	○	○	○
3000	○	○	○	○	○	○
2500	○	○	○	○	○	○
2000	○	○	○	○	○	○
1500	○	○	○	○	○	○
1200	○	○	○	○	○	○
1000	SK	○	○	○	○	○
800	SK	SC	○	○	○	○
600	SK	SC	TS	TZ(-SMD)	TY	TR(-SMD)
470	○	SC	TS	TZ(-SMD)	○	TR(-SMD)
420	SK	SC	TS	TZ(-SMD)	TY	TR(-SMD)
400	○	○	○	○	○	○
350	SK	SC	○	TZ(-SMD)	TY	TR(-SMD)
300	○	○	TS	○	○	○
250	○	SC	○	○	TY	○
230	○	SC	TS	TZ(-SMD)	TY	TR(-SMD)
200	○	○	TS	TZ(-SMD)	○	○
150	○	SC	TS	TZ(-SMD)	○	TR(-SMD)
90	SK	SC	TS	TZ(-SMD)	○	TR(-SMD)
75	○	SC	○	TZ(-SMD)	○	○
70	○	SC	○	○	○	○
Size (mm)	Φ8.0 × 2.2	6.0 × 8.3 × 8.3	6.8 × 3.5 × 3.5	7.6 × 5.0 × 5.0	7.8 × 5.0 × 5.0	10.0 × 8.3 × 8.3
I_n (8/20 μs) (kA) Impulse Discharge Current	10 / 20	20	3	5 / 10	5	10 / 20
Product Structure						
				SMD		

Gas Discharge Tube (GDT) Features & Model List Overview

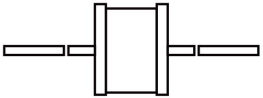
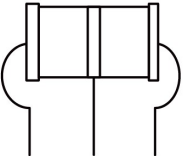
DC Spark-over Voltage (V)	Model					
	SD(-L)	SF	SE	TZ(-L)	TB	TR(-L)
4500	○	SF	SE	○	○	○
4000	○	SF	SE	○	○	○
3600	○	SF	SE	○	○	○
3000	○	SF	SE	○	○	○
2500	○	SF	SE	○	○	○
2000	○	SF	SE	○	○	○
1500	○	SF	SE	○	○	○
1200	○	○	SE	○	○	○
1000	○	SF	SE	○	○	○
800	SD(-L)	SF	SE	○	○	○
600	SD(-L)	SF	SE	TZ(-L)	TB	TR(-L)
470	SD(-L)	SF	SE	TZ(-L)	TB	TR(-L)
420	SD(-L)	SF	SE	TZ(-L)	TB	TR(-L)
400	○	○	○	○	○	○
350	SD(-L)	SF	SE	TZ(-L)	TB	TR(-L)
300	○	○	○	○	○	○
250	SD(-L)	SF	SE	○	○	○
230	SD(-L)	SF	SE	TZ(-L)	TB	TR(-L)
200	○	○	○	TZ(-L)	○	○
150	SD(-L)	SF	SE	TZ(-L)	TB	TR(-L)
90	SD(-L)	SF	SE	TZ(-L)	TB	TR(-L)
75	SD(-L)	SF	SE	TZ(-L)	○	○
70	SD(-L)	SF	SE	○	○	○
Size (mm)	Φ5.0 × 5.0	Φ5.5 × 6.0	Φ8.0 × 6.0	7.6 × 5.0 × 5.0	Φ6.0 × 8.0	Φ8.0 × 10.0
I_n (8/20 μs) (kA) Impulse Discharge Current	5	3 / 5 / 10	5 / 10 / 20	5 / 10	10	10 / 20
Product Structure				DIP		

Gas Discharge Tube (GDT) Features & Model List Overview

DC Spark-over Voltage (V)	4500	○	○	○	○	○	○	○	○	○	○	○	○	○
	4000	○	○	○	○	○	○	○	○	○	○	○	○	○
	3600	○	○	○	○	○	○	○	○	○	○	○	○	○
	3000	○	○	○	○	○	○	○	○	○	○	○	○	○
	2500	○	○	○	○	○	○	○	○	○	○	○	○	○
	2000	SPB	○	○	○	○	○	○	○	○	○	○	○	○
	1500	SPB	○	SPJ	○	○	SPI	○	○	○	○	○	○	○
	1400	○	○	○	○	○	○	○	○	○	○	○	○	TPA
	1000	SPB	SPC	SPJ	○	○	○	○	○	○	○	○	○	○
	800	SPB	SPC	SPJ	SPA	SPH	SPI	SPK	SPR	SPV	SPS	SPP	TPA	○
	600	SPB	SPC	SPJ	SPA	SPH	SPI	SPK	SPR	SPV	SPS	SPP	○	○
	470	○	○	○	○	○	○	○	○	○	○	○	○	○
	420	○	○	○	○	○	○	○	○	○	○	○	○	○
	400	○	○	○	○	○	○	○	○	○	○	○	○	○
	350	SPB	SPC	SPJ	SPA	SPH	SPI	○	○	SPV	○	○	○	○
300	○	○	○	○	○	○	○	○	○	○	○	○	○	
250	○	○	○	○	○	○	○	○	○	○	○	○	○	
230	○	○	○	○	○	○	○	○	○	○	○	○	○	
200	○	○	○	○	○	○	○	○	○	○	○	○	○	
150	SPB	○	○	○	○	○	○	○	○	○	○	○	○	
90	SPB	○	○	○	○	○	○	SPK	○	○	○	○	○	
75	○	○	○	○	○	○	○	○	○	○	○	○	○	
70	○	○	○	○	○	○	○	○	○	○	○	○	○	
Size (mm)	Φ11.8 × 6.2	Φ11.8 × 4.2	Φ16.0 × 4.5	Φ11.8 × 17.0	Φ18.0 × 6.7	Φ16.0 × 8.0	Φ15.0 × 3.0	Φ20.0 × 6.0	Φ20.0 × 4.0	Φ24.0 × 10.0	Φ30.0 × 12.0	16 × 8.4 × 9.3		
I_n (8/20 μs) (kA) Impulse Discharge Current	20		40						80	100	20			
Product Structure														

High Current
(May increase each kind of connect mode according to the customer different demand.)